

CAD FILE:

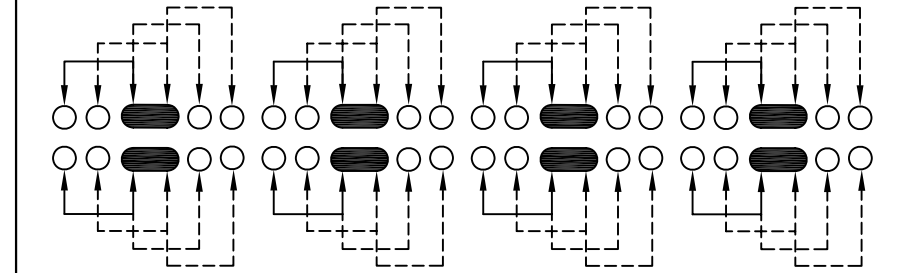

SCHEMATIC (SHORTING)

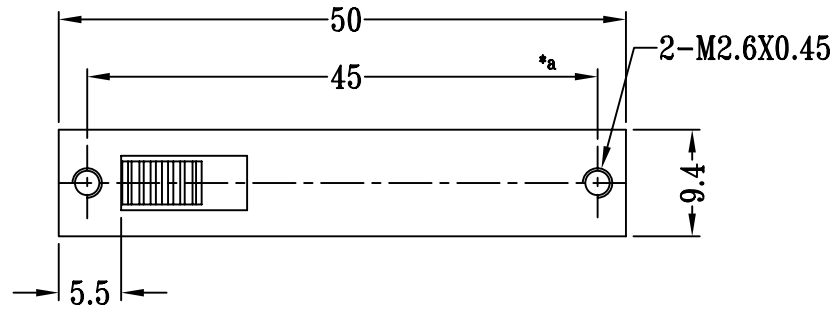
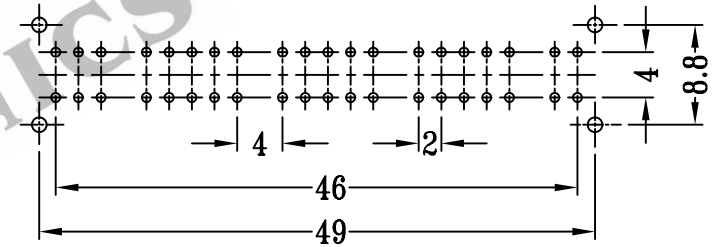
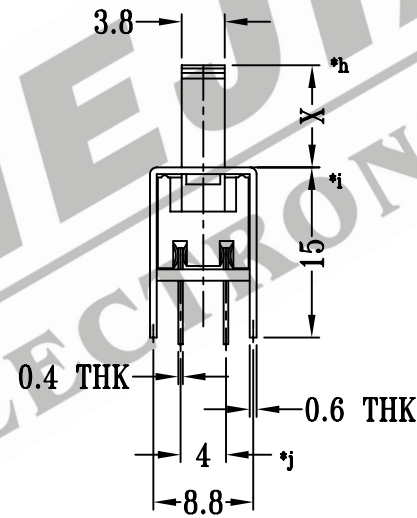
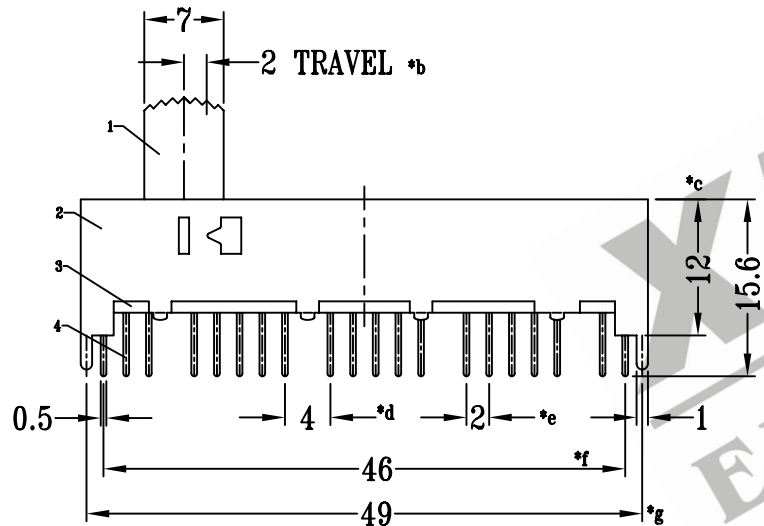

P.C.B LAYOUT

注:带"*"表示关键尺寸(10个)

NO.	PARTS	MATERIALS	QTY	FINISH	TOLERANCE UNLESS SPECIFIED	SHENZHEN XIEJIA ELECTRONICS CO.,LTD.				
8					WITHIN : 1.5±0.1mm OVER : 1.5±0.2mm	ISSUE	DATE	DESCRIPTIONS OF REVISION		APPD
7	CONTACT CLIP	PBS STRIP	8	Ag PLATED		TITLE: VERTICAL SLIDE SWITCH				
6	STEEL BALL	STEEL	2	NATURAL		UNIT : mm				
5	SPRING	STEEL WIRE	1	TEMPER	MODEL: SS-84D02					
4	TERMINAL	BRASS STRIP	40	Ag PLATED OVER Ni PLATED	SCALE: 3:2					
3	BASE	PHENOLIC RESIN	1	NATURAL	DRWG NO.: XJ-DR-SS84D02-00					
2	FRAME	STEEL STRIP	1	Ni PLATED	DWN ZHOUYU 2003-4-21					
1	KNOB	POM	1	BLACK	CHK'D FANGYING 2003-4-21					
ALL MATERIALS MUST BE COMPLIANT TO ROHS					APPD KANGXINAN 2003-4-21					